

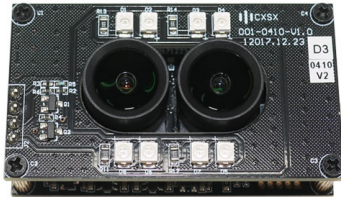

## YDS-USB-0409-0410 V2

### 2MP 0409 0410 OmniVision OV2710 M12 Fixed Focus LED Dual Lens Stereo USB 2.0 Camera Module



YDS-USB-0409-0410 V2 is a Dual Lens Stereo Type 2MP Fixed Focus USB camera module based on 1/2.7" OV2710 image sensor. It delivers high-speed, 2K resolution ultra sharp image in RGB (Color) and IR (Black and White).

The S-mount (M12) lens holder enables customers to choose different lens as per varies applications. This camera module is ideal solution for face recognition, identity detection, access control.

#### Key Features

- 2K resolution (1920 x 1080) OmniVision OV2710 sensor
- Dual lens stereo cameras (Color and Black/White)
- High speed USB 2.0 Plug and Play
- MJPEG and YUV2 output format
- Low power consumption
- Compact size
- UVC compliant to Windows, Linux, OS with UVC driver
- USB OTG (On-The-Go) support



# YDS CAMERA MODULE

*your best camera partner*

## YDS-USB-0409-0410 V2

**2MP 0409 0410 OmniVision OV2710 M12 Fixed Focus LED Dual Lens Stereo USB 2.0 Camera Module**

<b>Camera Module No.</b>	<b>YDS-USB-0409-0410 V2</b>
<b>Resolution</b>	2MP
<b>Image Sensor</b>	OV2710 (Color) / OV2710 (IR)
<b>Sensor Type</b>	1/2.7"
<b>Pixel Size</b>	3.0 um x 3.0 um
<b>EFL</b>	2.88 mm
<b>F.NO</b>	2.20
<b>Pixel</b>	1920 x 1080
<b>View Angle</b>	95.8°(DFOV) 87.8°(HFOV) 57.2°(VFOV)
<b>Lens Dimensions</b>	14.00 x 14.00 x 17.25 mm
<b>Module Type</b>	Fixed Focus
<b>Interface</b>	USB 2.0
<b>Output Format</b>	MJPEG / YUV2
<b>Auto Control</b>	Saturation, Contrast, Acutance White Balance, Exposure
<b>Audio</b>	None
<b>Input Voltage</b>	DC 5V
<b>Working Current</b>	Max 500mA
<b>PCB Size</b>	57.00 x 30.00 x 17.25 mm
<b>System Compatibility</b>	Windows XP (SP2, SP3), Vista, 7, 8, 10, 11 Android, Mac OS, Linux or OS with UVC Driver Raspberry Pi by USB Port
<b>Software for USB Camera</b>	AMCAP, Webcam Viewer, V4L2 Controls Contacam, VLC Player, MotionEye OS iSpy, ZoneMider, Yawcam
<b>Lens Type</b>	650nm IR Cut / 850nm IR Pass
<b>Operating Temperature</b>	-30°C to +85°C
<b>USB Cable</b>	USB Cable

Wide Compatibility with Windows, Android, Mac OS, Linux, or Raspberry Pi



[www.YDSCAM.com](http://www.YDSCAM.com) [sales@ydscam.com](mailto:sales@ydscam.com) Phone (WeChat, QQ): (+86) 177 2732 6718

All rights reserved @ YingDeShun Co. Ltd. Specifications subject to change without notice.



# YDS CAMERA MODULE

*your best camera partner*

## YDS-USB-0409-0410 V2

**2MP 0409 0410 OmniVision OV2710 M12 Fixed Focus LED Dual Lens  
Stereo USB 2.0 Camera Module**

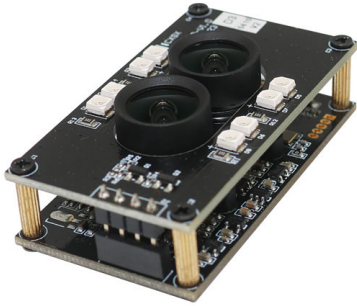

Top View

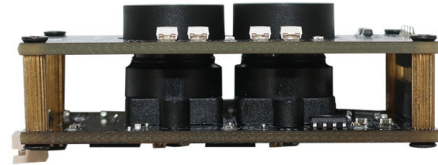

Side View

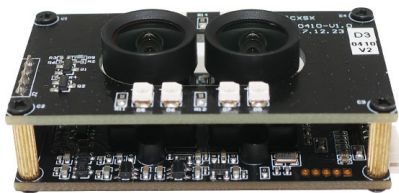

Bottom View



USB Cable

[www.YDSCAM.com](http://www.YDSCAM.com) [sales@ydscam.com](mailto:sales@ydscam.com) Phone (WeChat, QQ): (+86) 177 2732 6718

All rights reserved @ YingDeShun Co. Ltd. Specifications subject to change without notice.



## YDS-USB-0409-0410 V2

**2MP 0409 0410 OmniVision OV2710 M12 Fixed Focus LED Dual Lens Stereo USB 2.0 Camera Module**

FORMAT	RESOLUTION	FRAME RATE
		USB 2.0
MJPG	640 x 480 (VGA)	15 FPS
	1280 x 720 (720P)	15 FPS
	1920 x 1080 (1080P)	15 FPS
YUV2	640 x 480 (VGA)	15 FPS
	1280 x 720 (720P)	10 FPS
	1920 x 1080 (1080P)	5 FPS

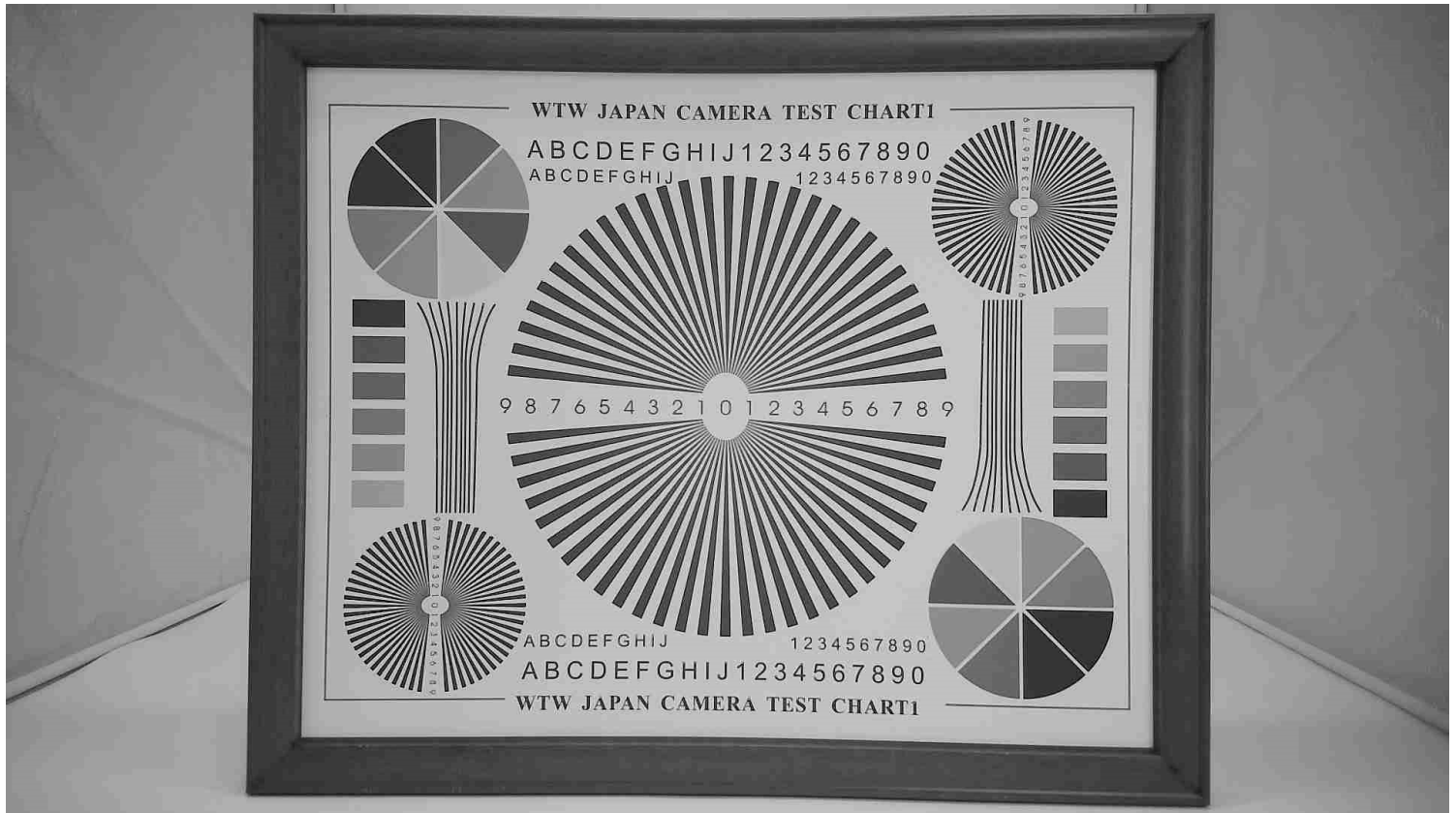





# YDS CAMERA MODULE

*your best camera partner*



[www.YDSCAM.com](http://www.YDSCAM.com) [sales@ydscam.com](mailto:sales@ydscam.com) Phone (WeChat, QQ): (+86) 177 2732 6718

All rights reserved @ YingDeShun Co. Ltd. Specifications subject to change without notice.





# YDS CAMERA MODULE

*your best camera partner*

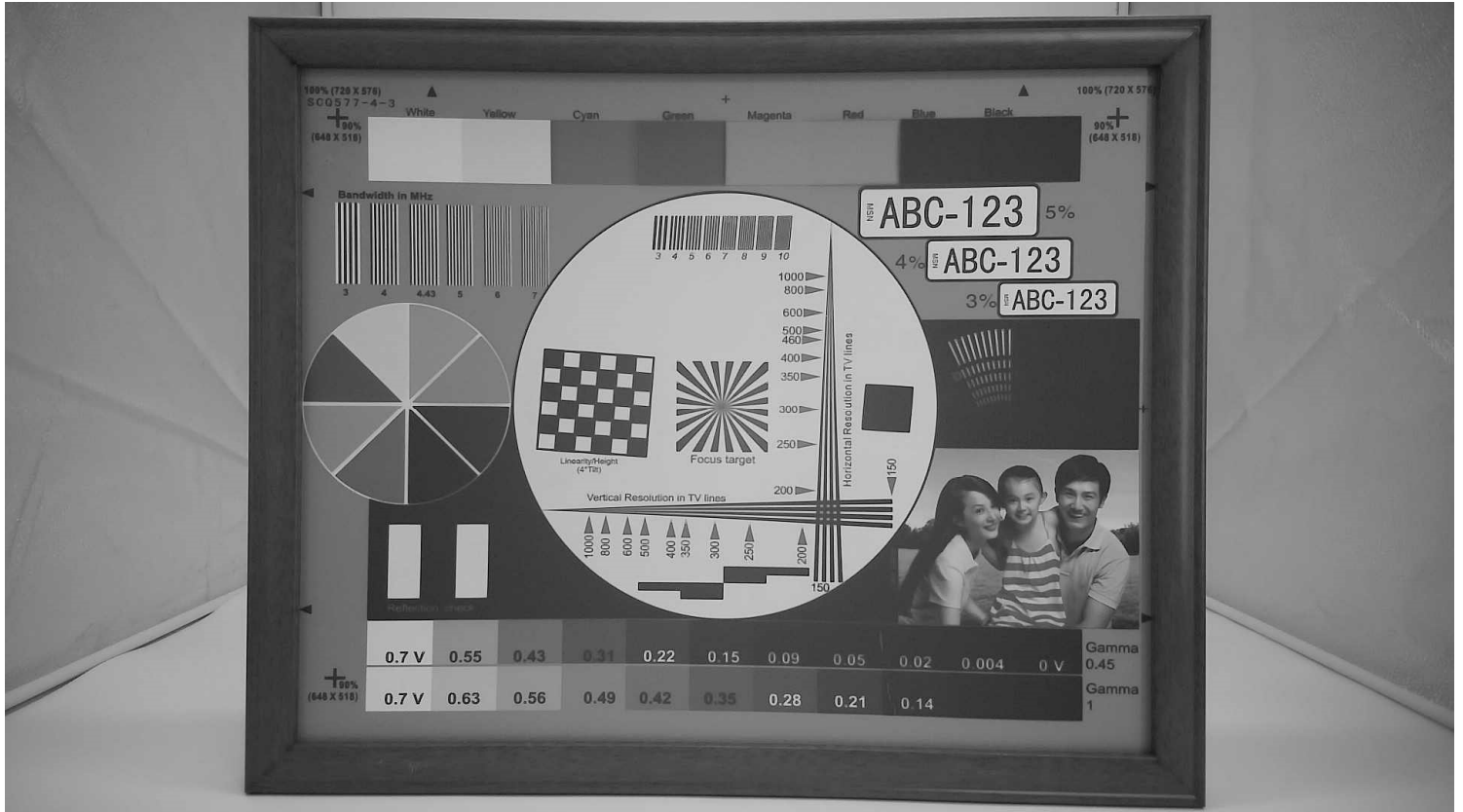
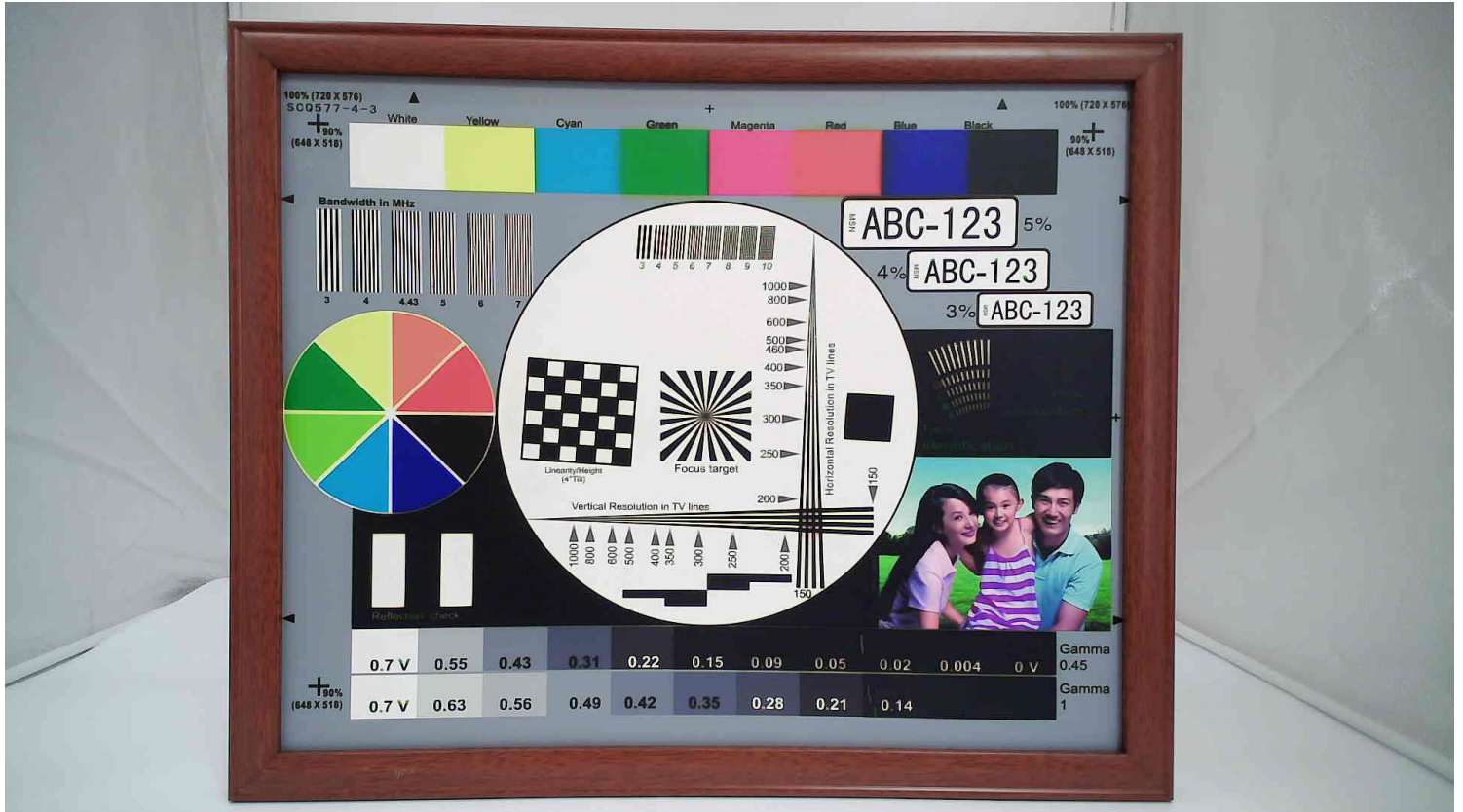

[www.YDSCAM.com](http://www.YDSCAM.com) [sales@ydscam.com](mailto:sales@ydscam.com) Phone (WeChat, QQ): (+86) 177 2732 6718

All rights reserved @ YingDeShun Co. Ltd. Specifications subject to change without notice.





# YDS CAMERA MODULE

*your best camera partner*



[www.YDSCAM.com](http://www.YDSCAM.com) [sales@ydscam.com](mailto:sales@ydscam.com) Phone (WeChat, QQ): (+86) 177 2732 6718

All rights reserved @ YingDeShun Co. Ltd. Specifications subject to change without notice.

NO.	SYMBOL
1	VDD 5V
2	D-
3	D+
4	GND

Version	Information	Date
V1.0	First Version	5-27-2022
V2.0	Change lens and holder	2-20-2023

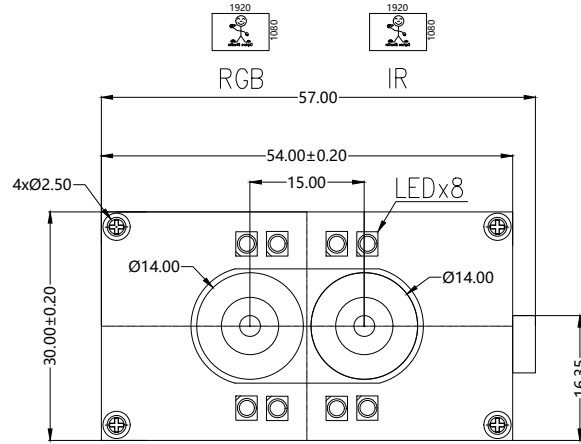

TOP VIEW

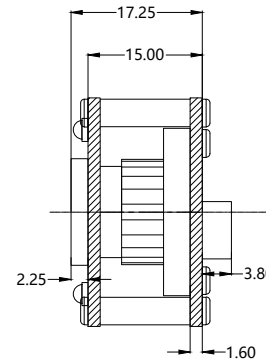

SIDE VIEW

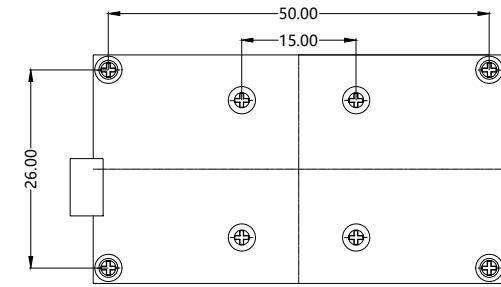

BOTTOM VIEW

**Parameters:**

**1、Sensor specification:**

Image Sensor: OV2710 X2

Pixel: 3.0um\*3.0um

Lens Type: 1/2.7

Important Voltage Description:

USB 5V (external power supply);

**2、Lens specification:**

FOV: 95.8°(D);87.8°(H);57.2°(V)

F/NO.: 2.2

TV distortion: <0.2%

Focal length: 2.88mm

Composition: 1G4P+IR FILTER

IR Cut Coating: 650nm±10nm@50%

Designed By

Kevin

Model Name:

USB-0409-0410 V2

Checked By

Aouly\_Yan

Projection Type:

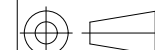

Third Angle

Unit:

mm

Scale:

1:1

Material:

-----

Sheet:

1 of 1

Version:

1/0

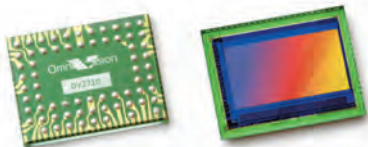

# OV2710-1E full HD (1080p) product brief



## OmniVision's True 1080p High Definition (HD) Video Image Sensor



available in  
a lead-free  
package

The OV2710-1E is a true full HD (1080p) CMOS image sensor designed specifically to deliver high-end HD video to digital video camcorders, notebooks, PC webcam, security and other mobile applications. The 1/2.7-inch OV2710-1E addresses the fast growing demand for affordable, HD-quality digital video solutions for video conferencing and recording.

The OV2710-1E is among the very first no-compromise full HD (1080p) sensors available on the market, meaning it offers HD video format with a display resolution of 1920 x 1080 pixels, operating at 30 frames per second. Built with OmniVision's proprietary 3  $\mu\text{m}$  OmniPixel3-HS™ high sensitivity pixel technology, the OV2710-1E delivers low-light sensitivity of 3700 mV/lux-sec, S/N ratio of 40 dB, and

a peak dynamic range of 69 dB, enabling cameras to operate in virtually every lighting condition from bright daylight to nearly complete darkness below 15 lux.

The OV2710-1E supports multiple platform architectures and controllers with both parallel and MIPI interfaces. By allowing system designers to leverage the same opto-electrical design across various products and multiple market segments, the OV2710-1E significantly reduces product development time. OmniVision's OmniPixel3-HS pixel technology has already been proven in high quality webcam/video applications and is now available in 1080p full HD in the OV2710-1E.

Find out more at [www.ovt.com](http://www.ovt.com).



**OmniVision**

## Applications

- Notebooks
- PC Webcams
- Camcorders
- Security
- Digital Still Cameras
- Telepresence
- Portable Media Players

## Product Features

- programmable controls: gain, exposure, frame rate, image size, horizontal mirror, vertical flip, cropping, windowing, and panning
- automatic image control functions:
  - automatic exposure (AEC)
  - automatic gain control (AGC)
  - automatic white balance (AWB)
  - automatic black level calibration (ABLCL)
- serial camera control bus (SCCB)
- lens correction (LENC)
- defect pixel correction (DPC)
- support for digital video port (DVP) parallel output interface
- integrated auto focus filter
- support for one lane MIPI interface (up to 800 Mbps)
- support for 8-/10-bit RAW RGB output format
- support for image sizes:
  - 1080p at 30 fps
  - cropped 720p at 60 fps
  - VGA at 120 fps
- support for black sun cancellation
- embedded one-time programmable (OTP) memory
- on-chip phase lock loop (PLL)
- built-in 1.5V regulator for core

# OV2710-1E



## Ordering Information

- OV2710-A68A-1E  
(color, lead-free, 68-pin CSP3)

## Product Specifications

- active array size: 1920 x 1080
- power supply:
  - analog: 3.0 - 3.6V (3.3V typical)
  - core: 1.425 - 1.575V (1.5V typical)
  - I/O: 1.7 - 3.6V (1.8V typical)
- power requirements:
  - active: 350 mW
  - power down: 70  $\mu$ A
- temperature range:
  - operating: -30°C to +85°C junction temperature
  - stable image: 0°C to +65°C junction temperature
- output interfaces: 10-bit parallel/one lane MIPI
- output formats: 10-bit RAW RGB
- lens size: 1/2.7"
- lens chief ray angle: 23.6°
- input clock frequency: 6 - 27 MHz
- scan mode: progressive
- maximum image transfer rate:
  - 1080p: 30 fps
  - cropped 720p: 60 fps
  - VGA: 120 fps
  - QVGA: 240 fps
- sensitivity: 3700 mV/lux-sec
- shutter: rolling
- max S/N ratio: 40 dB
- dynamic range: 69 dB @ 8x gain
- maximum exposure interval: 1096 tline
- pixel size: 3  $\mu$ m x 3  $\mu$ m
- dark current: 20 mV/sec @ 60°C junction temperature
- image area: 5856  $\mu$ m x 3276  $\mu$ m
- package dimensions: 7465  $\mu$ m x 5865  $\mu$ m

## Functional Block Diagram

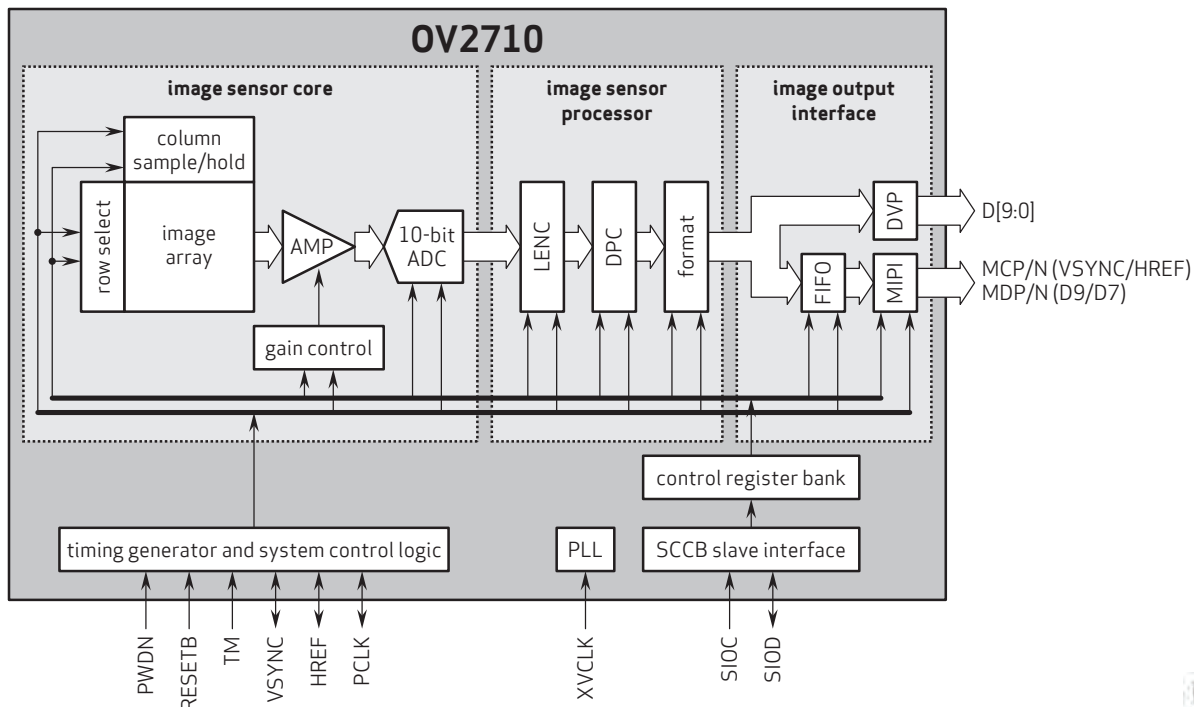

4275 Burton Drive  
Santa Clara, CA 95054  
USA

Tel: +1 408 567 3000  
Fax: +1 408 567 3001  
www.ovt.com

OmniVision reserves the right to make changes to their products or to discontinue any product or service without further notice. OmniVision, the OmniVision logo and OmniPixel are registered trademarks of OmniVision Technologies, Inc. OmniPixel3-H5 is a trademark of OmniVision Technologies, Inc. All other trademarks are the property of their respective owners.



OmniVision

## Cameras Applications



Automotive Driver Pilot



Live Streaming



Video Conference



Eye Tracker Biometric Detection

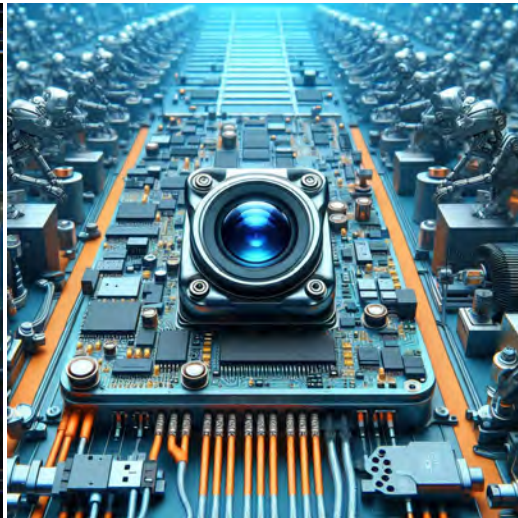

Machine Vision



Agricultural Monitor



Night Vision Security



Drone and Sports Eagle Eyes



Interactive Pet Camera



# YDS CAMERA MODULE

*your best camera partner*

## Camera Module Pinout Definition Reference Chart

OmniVision	Sony	Samsung	On-Semi	Aptina	Himax	GalaxyCore	PixArt	SmartSens	Sensors
Pin Signal		Description							
DGND GND		ground for digital circuit							
AGND		ground for analog circuit							
PCLK DCK		DVP PCLK output							
XCLR PWDN XSHUTDOWN STANDBY		power down active high with internal pull-down resistor							
MCLK XVCLK XCLK INCK		system input clock							
RESET RST		reset active low with internal pull-up resistor							
NC NULL		no connect							
SDA SIO_D SIOD		SCCB data							
SCL SIO_C SIOC		SCCB input clock							
VSYNC XVS FSYNC		DVP VSYNC output							
HREF XHS		DVP HREF output							
DOVDD		power for I/O circuit							
AFVDD		power for VCM circuit							
AVDD		power for analog circuit							
DVDD		power for digital circuit							
STROBE FSTROBE		strobe output							
FSIN		synchronize the VSYNC signal from the other sensor							
SID		SCCB last bit ID input							
ILPWM		mechanical shutter output indicator							
FREQ		frame exposure / mechanical shutter							
GPIO		general purpose inputs							
SLASEL		I2C slave address select							
AFEN		CEN chip enable active high on VCM driver IC							
<b>MIPI Interface</b>									
MDN0 DN0 MD0N DATA_N DMO1N		MIPI 1st data lane negative output							
MDP0 DP0 MD0P DATA_P DMO1P		MIPI 1st data lane positive output							
MDN1 DN1 MD1N DATA2_N DMO2N		MIPI 2nd data lane negative output							
MDP1 DP1 MD1P DATA2_P DMO2P		MIPI 2nd data lane positive output							
MDN2 DN2 MD2N DATA3_N DMO3N		MIPI 3rd data lane negative output							
MDP2 DP2 MD2P DATA3_P DMO3P		MIPI 3rd data lane positive output							
MDN3 DN3 MD3N DATA4_N DMO4N		MIPI 4th data lane negative output							
MDP3 DP3 MD3P DATA4_P DMO4P		MIPI 4th data lane positive output							
MCN CLKN CLK_N DCKN		MIPI clock negative output							
MCP CLKP MCP CLK_P DCKN		MIPI clock positive output							
<b>DVP Parallel Interface</b>									
D0 DO0 Y0		DVP data output port 0							
D1 DO1 Y1		DVP data output port 1							
D2 DO2 Y2		DVP data output port 2							
D3 DO3 Y3		DVP data output port 3							
D4 DO4 Y4		DVP data output port 4							
D5 DO5 Y5		DVP data output port 5							
D6 DO6 Y6		DVP data output port 6							
D7 DO7 Y7		DVP data output port 7							
D8 DO8 Y8		DVP data output port 8							
D9 DO9 Y9		DVP data output port 9							
D10 DO10 Y10		DVP data output port 10							
D11 DO11 Y11		DVP data output port 11							

[www.YDSCAM.com](http://www.YDSCAM.com) [sales@ydscam.com](mailto:sales@ydscam.com) Phone (WeChat, QQ): (+86) 177 2732 6718

All rights reserved @ YingDeShun Co. Ltd. Specifications subject to change without notice.

## Camera Reliability Test

Reliability Inspection Item		Testing Method	Acceptance Criteria	
Category	Item			
Environmental	Storage Temperature	High 60°C 96 Hours	Temperature Chamber	No Abnormal Situation
		Low -20°C 96 Hours	Temperature Chamber	No Abnormal Situation
	Operation Temperature	High 60°C 24 Hours	Temperature Chamber	No Abnormal Situation
		Low -20°C 24 Hours	Temperature Chamber	No Abnormal Situation
	Humidity	60°C 80% 24 Hours	Temperature Chamber	No Abnormal Situation
	Thermal Shock	High 60°C 0.5 Hours Low -20°C 0.5 Hours Cycling in 24 Hours	Temperature Chamber	No Abnormal Situation
Physical	Drop Test (Free Falling)	Without Package 60cm	10 Times on Wood Floor	Electrically Functional
		With Package 60cm	10 Times on Wood Floor	Electrically Functional
	Vibration Test	50Hz X-Axis 2mm 30min	Vibration Table	Electrically Functional
		50Hz Y-Axis 2mm 30min	Vibration Table	Electrically Functional
		50Hz Z-Axis 2mm 30min	Vibration Table	Electrically Functional
	Cable Tensile Strength Test	Loading Weight 4 kg 60 Seconds Cycling in 24 Hours	Tensile Testing Machine	Electrically Functional
Electrical	ESD Test	Contact Discharge 2 KV	ESD Testing Machine	Electrically Functional
		Air Discharge 4 KV	ESD Testing Machine	Electrically Functional
	Aging Test	On/Off 30 Seconds Cycling in 24 Hours	Power Switch	Electrically Functional
	USB Connector	On/Off 250 Times	Plug and Unplug	Electrically Functional



## Camera Inspection Standard

Inspection Item		Inspection Method	Standard of Inspection		
Category	Item				
Appearance	FPC/ PCB	Color	The Naked Eye	Major Difference is Not Allowed.	
		Be Torn/Chopped	The Naked Eye	Copper Crack Exposure is Not Allowed.	
		Marking	The Naked Eye	Clear, Recognizable (Within 30cm Distance)	
	Holder	Scratches	The Naked Eye	The Inside Crack Exposure is Not Allowed	
		Gap	The Naked Eye	Meet the Height Standard	
		Screw	The Naked Eye	Make Sure Screws Are Presented (If Any)	
		Damage	The Naked Eye	The Inside Crack Exposure is Not Allowed	
	Lens	Scratch	The Naked Eye	No Effect On Resolution Standard	
		Contamination	The Naked Eye	No Effect On Resolution Standard	
		Oil Film	The Naked Eye	No Effect On Resolution Standard	
		Cover Tape	The Naked Eye	No Issue On Appearance.	
	Function	Image	No Communication	Test Board	Not Allowed
			Bright Pixel	Black Board	Not Allowed In the Image Center
Dark Pixel			White board	Not Allowed In the Image Center	
Blurry			The Naked Eye	Not Allowed	
No Image			The Naked Eye	Not Allowed	
Vertical Line			The Naked Eye	Not Allowed	
Horizontal Line			The Naked Eye	Not Allowed	
Light Leakage			The Naked Eye	Not Allowed	
Blinking Image			The Naked Eye	Not Allowed	
Bruise			Inspection Jig	Not Allowed	
Resolution			Chart	Follows Outgoing Inspection Chart Standard	
Color			The Naked Eye	No Issue	
Noise			The Naked Eye	Not Allowed	
Corner Dark			The Naked Eye	Less Than 100px By 100px	
Color Resolution			The Naked Eye	No Issue	
Dimension	Height	The Naked Eye	Follows Approval Data Sheet		
	Width	The Naked Eye	Follows Approval Data Sheet		
	Length	The Naked Eye	Follows Approval Data Sheet		
	Overall	The Naked Eye	Follows Approval Data Sheet		



## YDSCAM Package Solutions

YDS Camera Module



Complete with Lens Protection Film

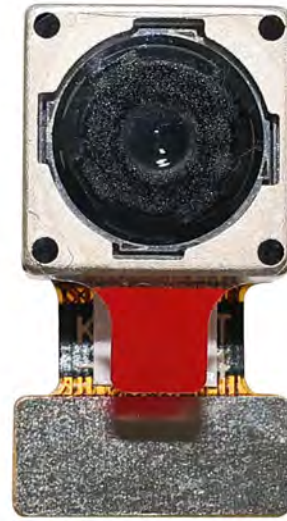

Tray with Grid and Space



Place Cameras on the Tray

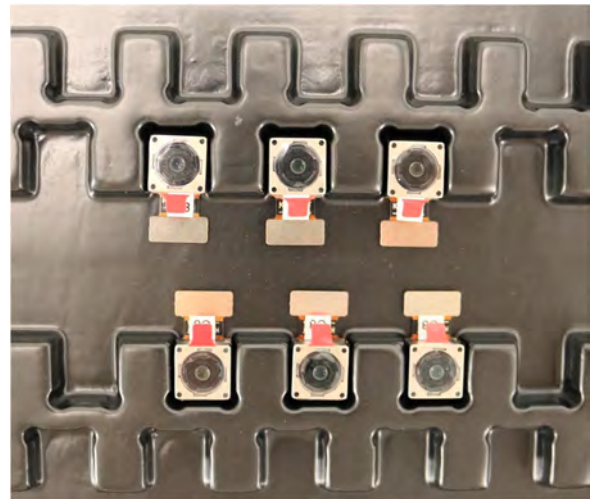

## YDSCAM Package Solutions

Full Tray of Cameras

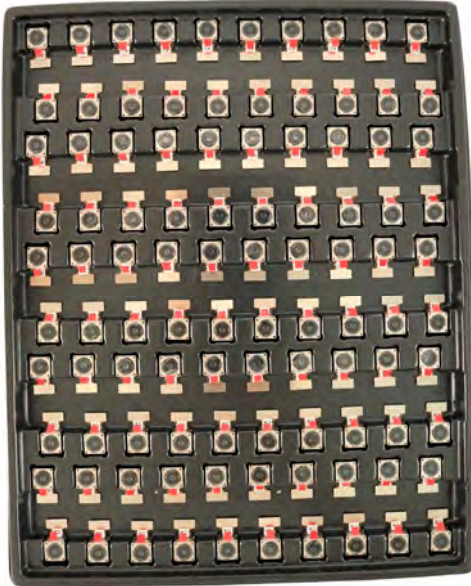

Cover Tray with Lid

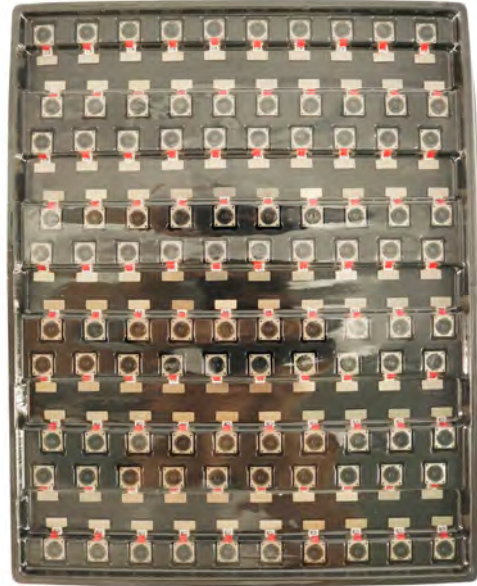

Place Tray into Anti-Static Bag



Vacuum the Anti-Static Bag



## YDSCAM Package Solutions

### Sealed Vacuum Anti-Static Bag with Labels

1. Model and Description 2. Quantity 3. Manufacturing Date Code 4. Caution



## YDSCAM Package Solutions

Place Foam Sheets Between Tray Bags



Foam Sheets are Larger Than Trays



Place Foam Sheets and Trays into Box



Foam Sheets are Tightly Fitting in Box



Seal the Carbon Box



Label the Carbon Shipping Box





## YDSCAM Package Solutions

USB Camera Module

Complete with Lens Protection Film

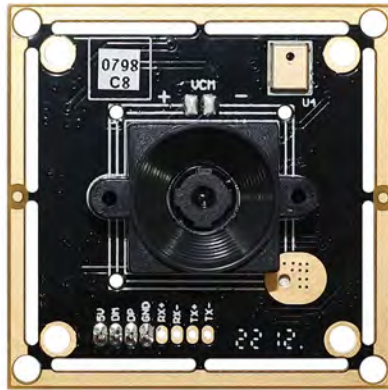

Place Camera Sample into Anti-Static Bag

Place USB Cameras into Tray



Seal the Tray with Anti-Static Bag

Label the Carbon Shipping Box



## YDSCAM Package Solutions

Place Camera Sample into Anti-Static Bag



Place Connectors into Anti-Static Bag



Label the Sample Bags



Place Connectors into Reel



Place Samples into the Carbon Box



Place Connectors into the Carbon Box





# YDS CAMERA MODULE

*your best camera partner*

## Company YDSCAM

YingDeShun Co. Ltd. (YDS) was established in 2017, a next-generation technology driven manufacturer specialized in research, design, and produce of audio and video products. YDS is occupying 20,000 square feet automated plants with 100 employees of annual throughput 30,000,000 units cameras.

YDS provides OEM, ODM design, contract manufacturing, and builds the camera products. You may provide the requirements to us, even with a hand draft, our sales and engineering work together to meet your needs. We consider ourselves your last-term partner in developing practical and innovative solutions.

Our team covers everything from initial concept development to mass produced product. YDS specializes in customized camera design, raw material, electronic engineering, firmware/software development, product testing, and packing design. Our experienced strategic supply systems offer a robust and dependable manufacturing capacity for orders of various sizes.

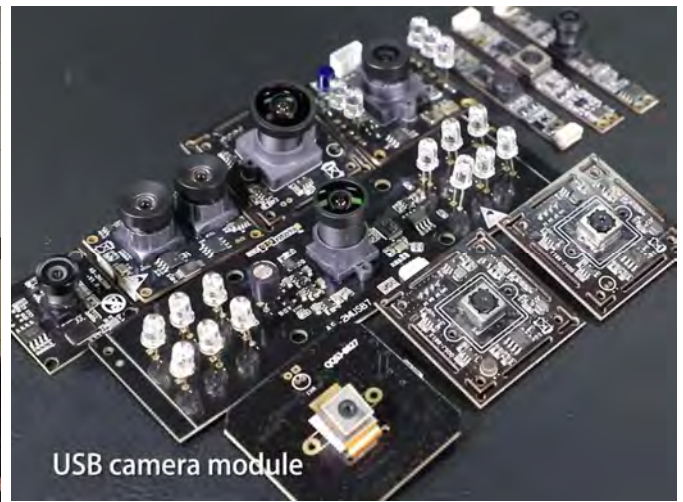

## Limited Warranty

YDS provides the following limited warranty if you purchased the Product(s) directly from YDS company or from YDS's website [www.YDSCAM.com](http://www.YDSCAM.com). Product(s) purchased from other sellers or sources are not covered by this Limited Warranty. YDS guarantees that the Product(s) will be free from defects in materials and workmanship under normal use for a period of one (1) year from the date you receive the product ("Warranty Period").

For all Product(s) that contain or develop material defects in materials or workmanship during the Warranty Period, YDS will, at its sole option, either: (i) repair the Product(s); (ii) replace the Product(s) with a new or refurbished Product(s) (replacement Product(s) being of identical model or functional equivalent); or (iii) provide you a refund of the price you paid for the Product(s).

This Limited Warranty of YDS is solely limited to repair and/or replacement on the terms set forth above. YDS is not reliable or responsible for any subsequent events.



[www.YDSCAM.com](http://www.YDSCAM.com) [sales@ydscam.com](mailto:sales@ydscam.com) Phone (WeChat, QQ): (+86) 177 2732 6718

All rights reserved @ YingDeShun Co. Ltd. Specifications subject to change without notice.



# YDS CAMERA MODULE

*your best camera partner*

## YDS Strength

### Powerful Factory



### Professional Service



### Promised Delivery



[www.YDSCAM.com](http://www.YDSCAM.com) [sales@ydscam.com](mailto:sales@ydscam.com) Phone (WeChat, QQ): (+86) 177 2732 6718

All rights reserved @ YingDeShun Co. Ltd. Specifications subject to change without notice.